

PD-P24 Cover Clip BII

**New protective
pump cover clip !**

PD-P0524BII Pump
CUBE-120A



PD-P24 Cover Clip BII
TAKEMOTO

PD-P0524BII W Core Pump
CUBE-120A



PD-P24 Cover Clip BII
TAKEMOTO



Introducing a new cover type clip that covers the pump head. By protecting the nozzle tip, you can offer security and peace of mind and add value to your product.



PD-P24 Cover Clip BII

— Pump head protection —

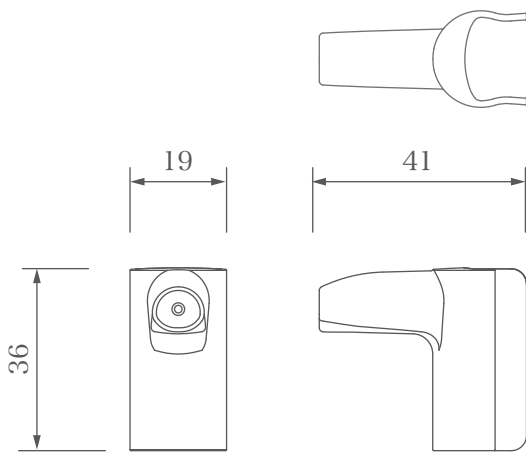

PD-P24 Cover Clip BII
Material : PP

■ Offer peace of mind

By covering of the head of the pump, the clip offers enhanced safety and security.

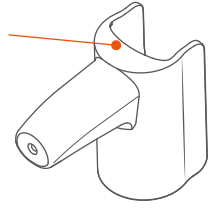

■ Compatible pumps

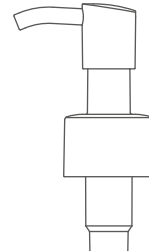

• PD-P0524B II Pump
• PD-P1024B II Pump

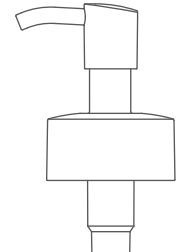

• PD-P0524B II W Core Pump
• PD-P1024B II W Core Pump

(Dose)
0.5cc
1.0cc

■ Clip construction

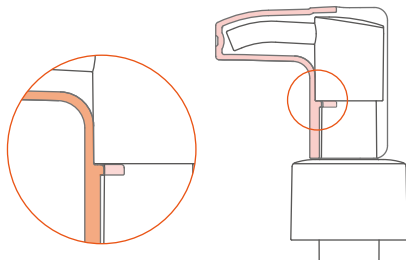

Ribs on the inner side of the clip prevent unwanted dispensing of formula.

■ Usage

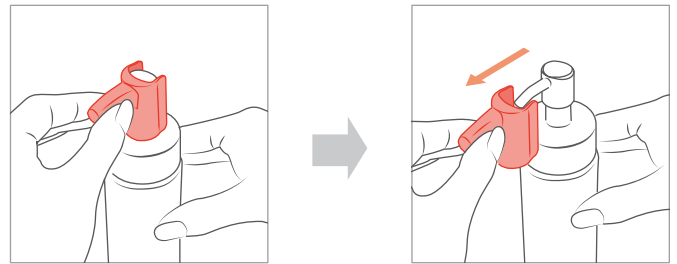

The clip is removed by holding the tip and pulling in the direction shown.

Suitable for a wide range of applications from essence and toner to milky lotion.



■ Selection of compatible containers

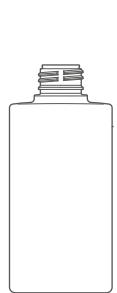

S-BPI-150A



EOPI-120

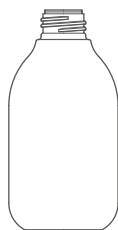

AOMP-200



VPZ-120 II



PTP-250



DPI-300



OPTI-300



EXI-150
EX Ring DI