

DBI-II Series

NEW

**Slim oval PET bottles ideal
for mail delivery!**



※ Actual size

These oval bottles are designed to fit mail boxes (30mm width). They look great on display and are perfect to take on the go. Available with various accessories, they are a perfect choice for items such as hotel amenities, samples, travel goods, and free giveaways.

DBI-II Series

— Slim oval bottles for mail delivery! —

※ 1 Molding method: "ISB" stands for "injection stretch blow molding".

※  area in the drawing indicates the maximum printable range in the case of pad printing.

15/415 Accessories

PPS Accessories

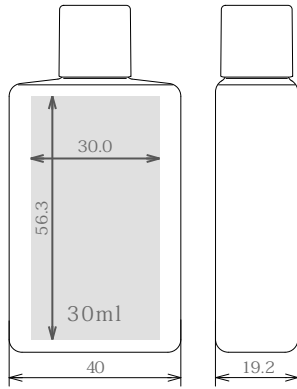

DBI II -30

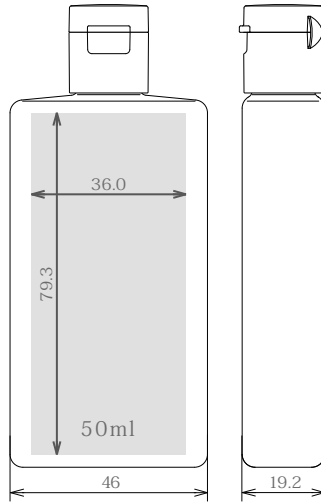
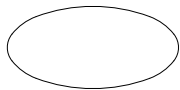

DBI II -50

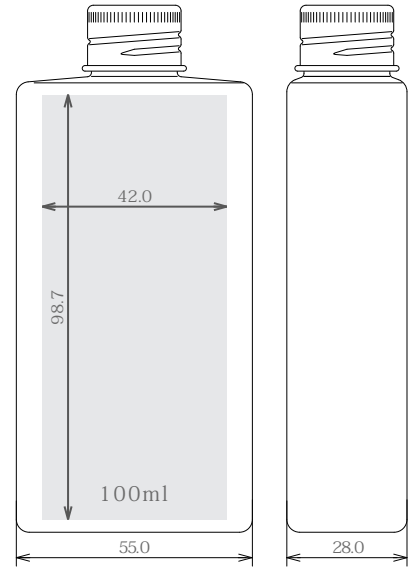
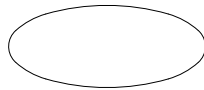

DBI II -100

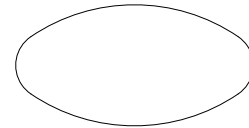

DBI-II series
Material
Bottle : PET
Molding method : ISB ※1

■ Easy to squeeze

Thin wall design makes the bottle easy to squeeze.

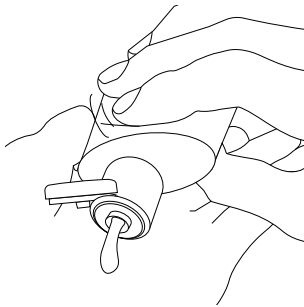

■ Large branding area

There is ample space for printing/labeling on both the front and back sides, allowing effective use of graphics.

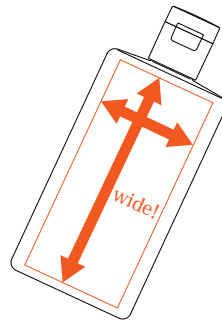

■ Mail box delivery size

Assuming the use of an outer box, bottle width has been set to 28mm (100ml) or less. Compared to flexible packaging, these bottles have real presence and are self-standing.

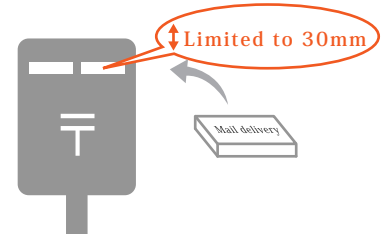

15/415 neck finish Accessories (International standard neck size)

15-415 Flip-Top Cap

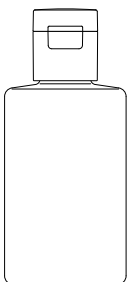

15-415 Inner ring Cap

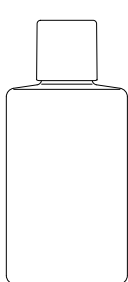

15-415 Nozzle cap L

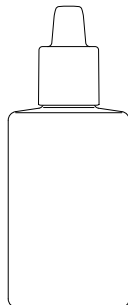

15-415 Nozzle Screw Cap-S



Nozzle shape
15-415
1.9φ Nozzle PlugL

15-415 Nozzle Screw Cap-S

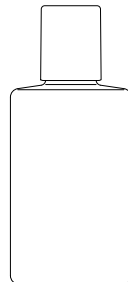

15-415 Nozzle Screw Cap-S



Nozzle shape
15-415
1.4φ Nozzle PlugS

15-415 Screw Cap

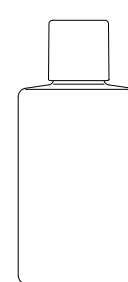

15-415 Plug

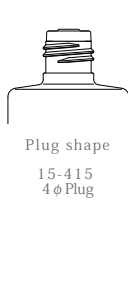

Plug shape
15-415
4φ Plug